

**CCAS0420-101/
CCAS0420-104/
CCAS0420-108**

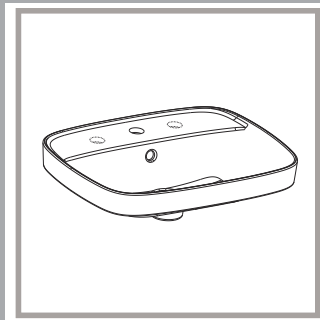

American Standard

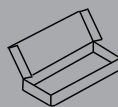
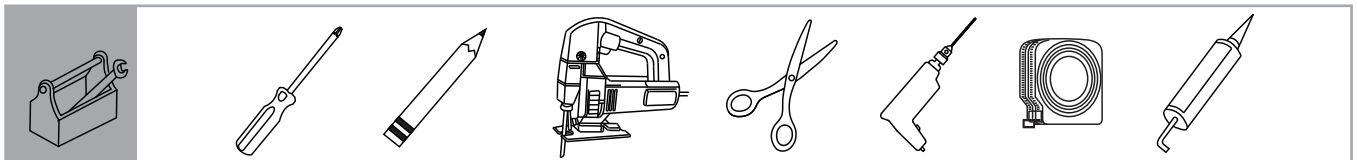
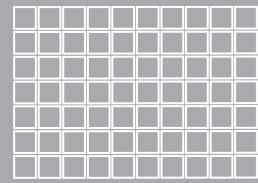

CCAS0420-101

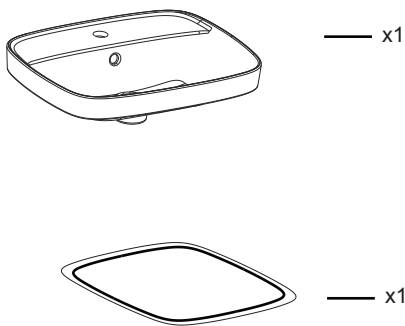

CCAS0420-104/108

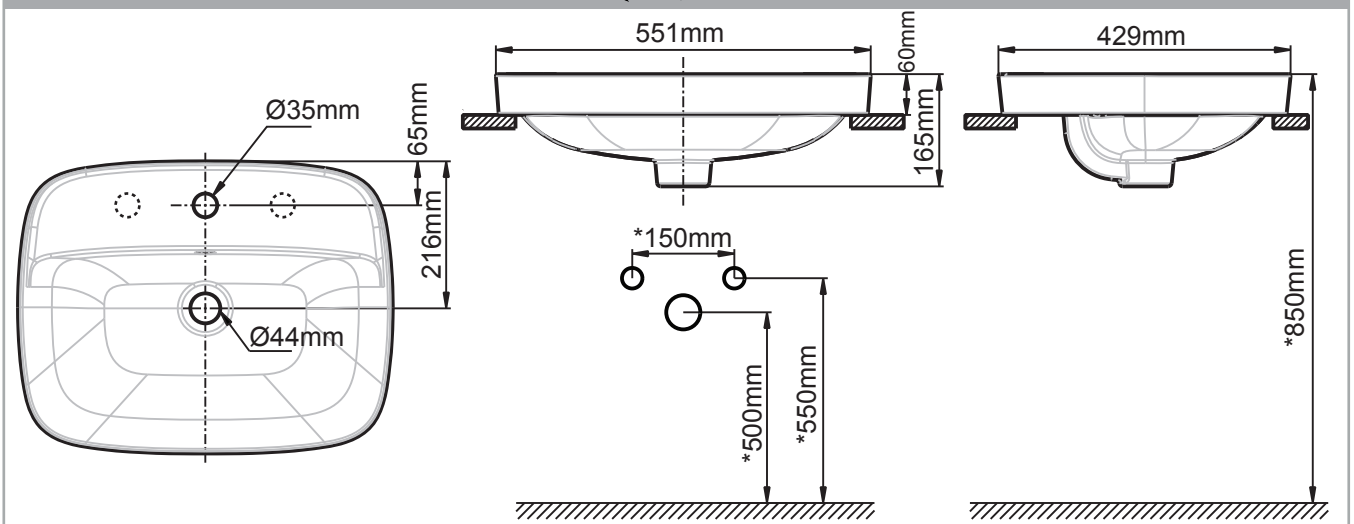
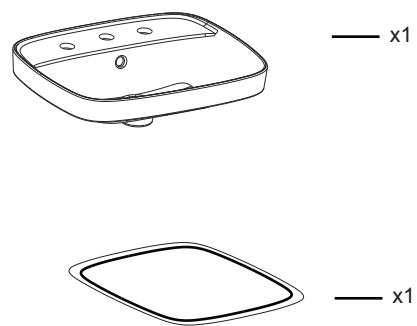

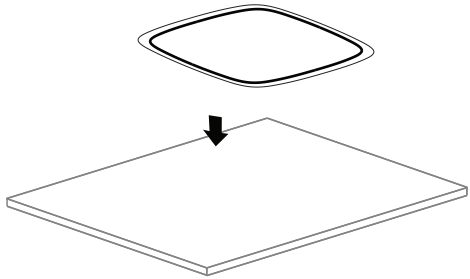

1

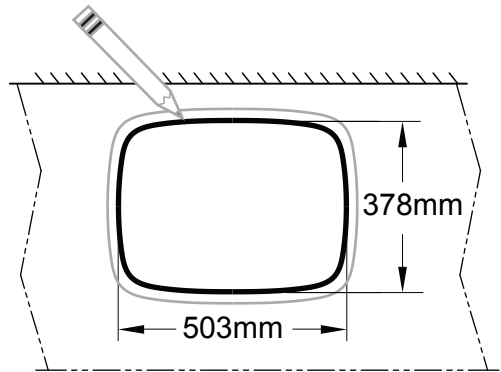

2

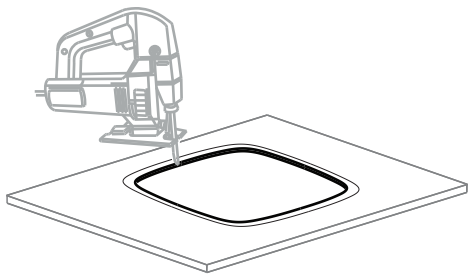

3

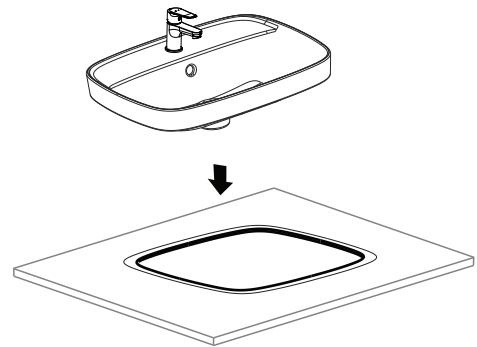

4

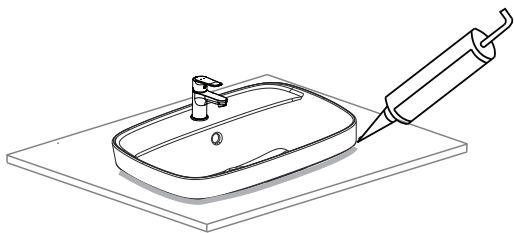

5

Do not use harsh abrasives or caustic cleansers to clean fixture surface. A mild detergent, warm water, and a soft cloth will remove normal dirt and soap accumulations from fittings and surfaces. Rinse thoroughly after cleaning and polish with a soft dry cloth to restore original luster of material.

不要用粗糙的研磨剂和腐蚀性的清洗器清洁产品表面。用温和的清洁剂，温和的水和一张软布就可以将配件和产品表面的一般污渍和肥皂聚积物清除干净。在清洗之后用柔软的干布将产品表面擦干使之恢复原有的光泽。